



Alpina Termoplásticos Ltda.

Av. Gal. Waldomiro de Lima, 717

Cep: 04344-070 - São Paulo - SP

Caixa Postal 3259

Telefone: (11) 5014-3200

Telefax: (11) 5014-3208

E-mail: termoplasticos@alpina.com.br

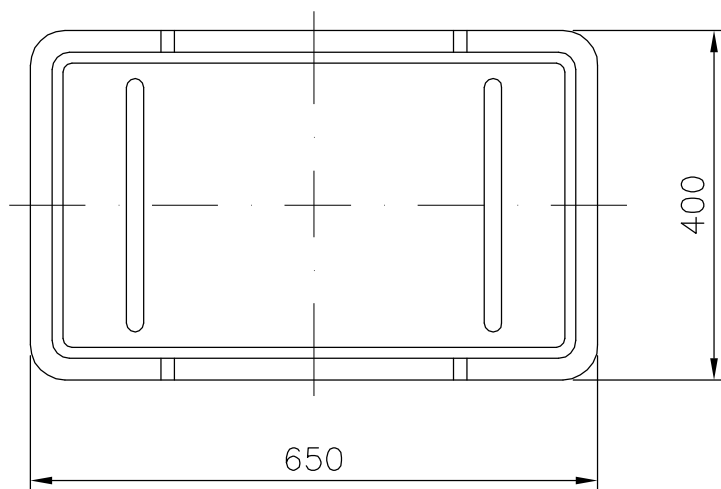
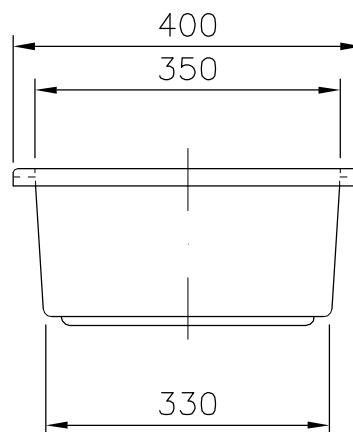
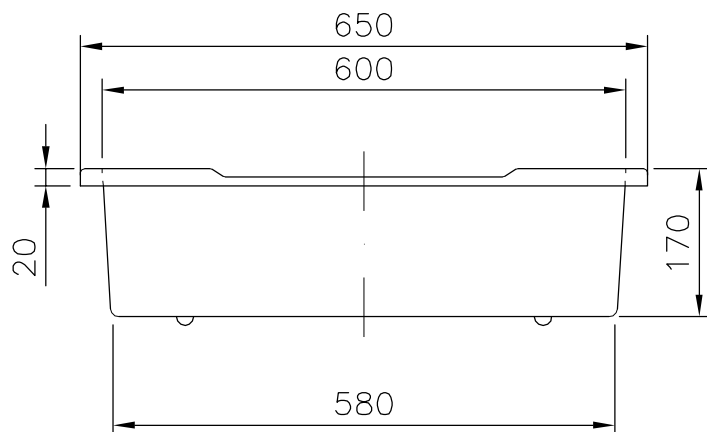

OBS:

-DIMENSÕES NOMINAIS SUJEITAS À TOLERÂNCIA DE $\pm 2\%$.

-MATERIAL: POLIETILENO.

19.01.06

CAPACIDADE NOMINAL: 35 LITROS.

CAÇAMBA SEM CARRINHO

REF: 001-484